

Low-Voltage Circuit Breakers

Selection Guide



TERASAKI circuit breakers. Our mature product line supports the wide ranging needs of our customers.

line supports



World Class Air Circuit Breaker

TemPower



Energy saving support
Power Monitoring Equipment

TemMeasure



Terasaki developed its original breaker for the first time in Japan in 1947. Since then, the company has been offering, as a specialized breaker manufacturer, the most advanced breakers not only to the Japanese market, but also to the world markets.

The TemBreak series of Moulded case circuit breakers, which is evaluated as highly reliable by our customers, has been improved from time to time for better performance through Terasaki's advanced technologies.

In 2000, the TemPower 2 series was released to replace the Tempower series of air circuit breakers, which had received high reputations for many years. This new series consists of small, high-performance air circuit breakers featuring advanced information and communication capabilities.

Terasaki is ready to meet the customers' requirements in the 21st century through its diversified model lineup and its broad range of enhanced products.



ISO9001 certificate

In September 1993, Terasaki obtained certification for the world quality assurance standard ISO9002.

In 1994, we obtained certification for the even more rigorous ISO9001 which covers additional items such as "Management Responsibilities", "Employee Training", "Design and Development", and "Service".

In the future, we will respond to the even higher level of global needs with "international reliability".



ISO14001 certificate

In April 2000, Terasaki was certified as conforming to ISO 14001, an international environment-related standard. The company gives priority to its commitment to the curtailment or abolishment of using environmentally harmful substances, energy saving in the production activities, reduction of wastes, and effective utilization of resources.

Contents

Company profile	2
1. TemPower	6
• Air Circuit Breakers AR	6
• Air Circuit Breakers AT•AH	8
• Air Circuit Breakers AME	9
2. TemBreak	10
1 Moulded Case Circuit Breakers	10
• Economical XE Series	10
• Standard XS Series	12
• High-fault Level XH Series	15
• Motor Protection XM Series	16
• D.C. Application Series	17
• Current-Limiting Breakers, TL Series	18
• TO/TT Series	20
• Mining Series	21
• Non-automatic Trip Breakers	22
• Thyristor Protection Breakers	24
• TB Series for Distribution Board use	25
• Adjustable Thermal Trip	26
• Marine Approval	28
2 Earth-leakage Relays	30
• TZS Series	30
3. TemMeasure	31
4. TemPlug	32
5. TemDin	33
6. Other Electrical Distribution Equipment	34
• Special Circuit Breakers	34

TERASAKI Profile

Established: October 1, 1923
President: Masakazu Fujita
Capital: 641 million yen
Number of employees: 813
Sales: (Mar. 2004) 19,353 million yen

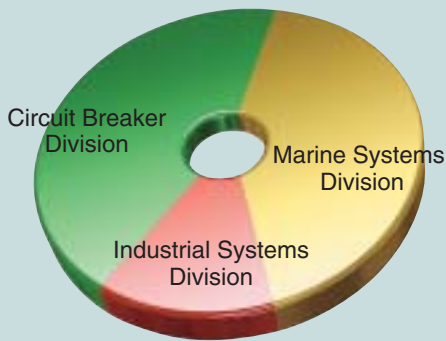

Line of business

- Marine Systems Division:**
 Power distribution systems, Engine monitoring & control systems, General instrumentation
- Industrial Systems Division:**
 Power distribution system, Co-generation system, Independent generation plant (distributed power supply), System engineering, Electronic equipment and systems for factory automation, Monitoring & control system
 Medical tools and equipment
- Circuit Breaker Division:**
 Moulded case circuit breakers, Air circuit breakers.
 Miniature circuit breakers, Power monitoring equipments

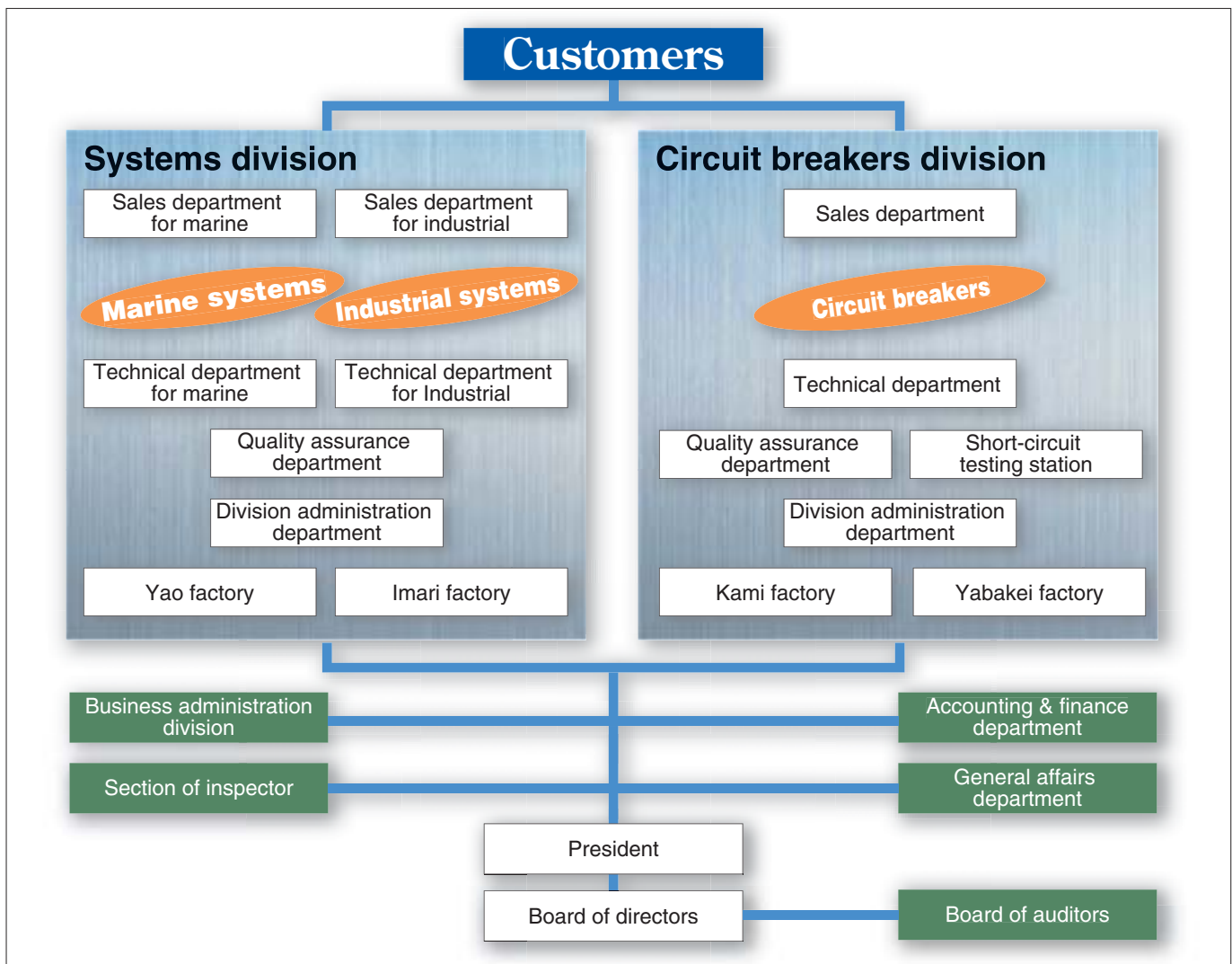

TERASAKI Global Network

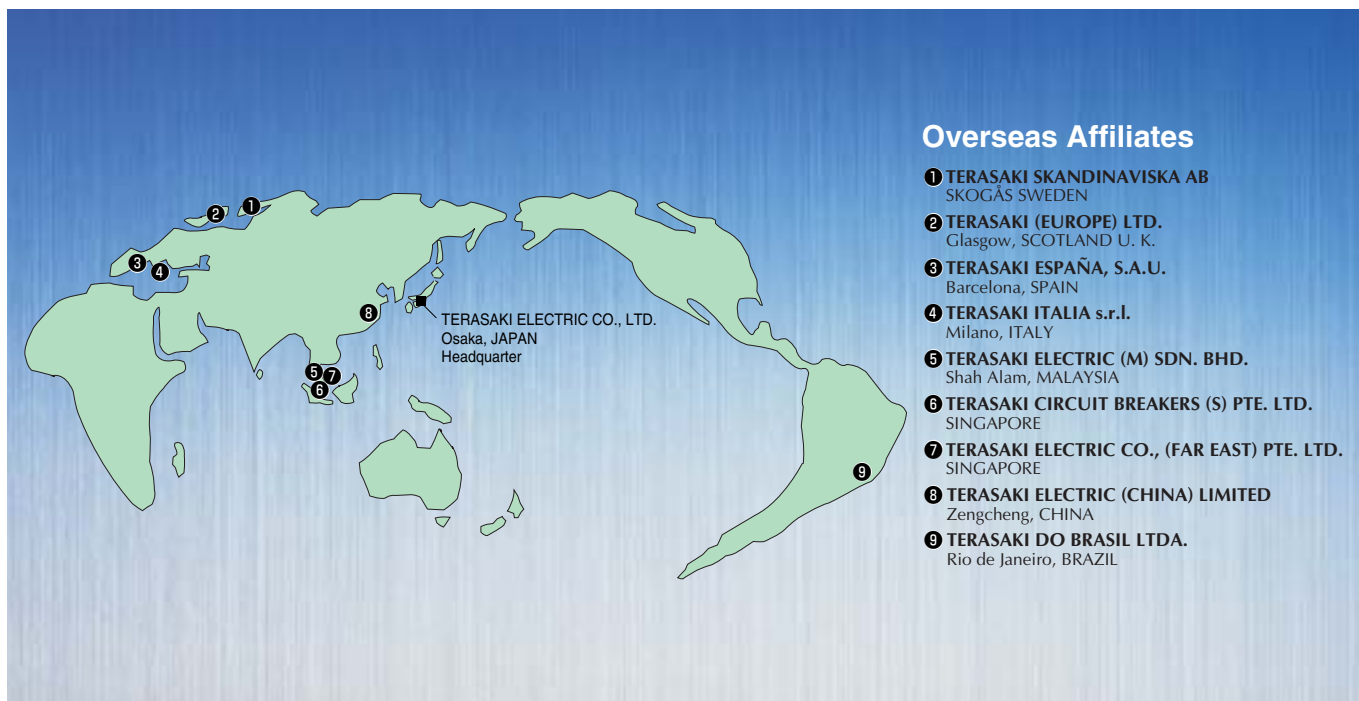

TERASAKI is always pleased to send you the world's top-class products.

Already for many decades TERASAKI has been internationally minded. This is proved by the number of certifications, authorizations and approvals by the world's leading organizations and authorities.

TERASAKI maintains the top position. TERASAKI will exert its further efforts to attain more international quality recognition.



Certifications, Authorizations or Approvals by World's Leading Organizations

Air Circuit Breakers
ASTA/U.K. ASTA CERTIFICATION SERVICES
SECV/Australia State Electricity Commission of Victoria
LR/U.K. Lloyd's Register of Shipping
BV/France Bureau Veritas
GL/Germany Germanischer Lloyd
AB/U.S.A. American Bureau of Shipping
NK/Japan Nippon Kaiji Kyokai

Moulded Case Circuit Breakers
ASTA/U.K. ASTA CERTIFICATION SERVICES
SECV/Australia State Electricity Commission of Victoria
LR/U.K. Lloyd's Register of Shipping
BV/France Bureau Veritas
GL/Germany Germanischer Lloyd
AB/U.S.A. American Bureau of Shipping
NK/Japan Nippon Kaiji Kyokai

Based Standards

Air Circuit Breakers
IEC 60947-2 International Electrotechnical Commission
BS EN 60947 Part 2/U.K. British Standard
VDE 0660 Part 101/Germany Verband Deutscher Elektrotechniker
NEMA PUB NO. SG3/U.S.A. National Electrical Manufacturers Association
ANSI C37. 13/U.S.A. American National Standard Institute
JIS C8372/Japan Japanese Industrial Standard
JEC-160/Japan Japanese Electrical Committee

Moulded Case Circuit Breakers
IEC 60947-2 International Electrotechnical Commission
BS EN 60947 Part 2/U.K. British Standard
VDE 0660 Part 101/Germany Verband Deutscher Elektrotechniker
CEI EN 60947 Part 101/Germany Italian Standard
NEMA AB-1/U.S.A. National Electrical Manufacturers Association
JIS C8370/Japan Japanese Industrial Standard

Short-circuit Testing Station

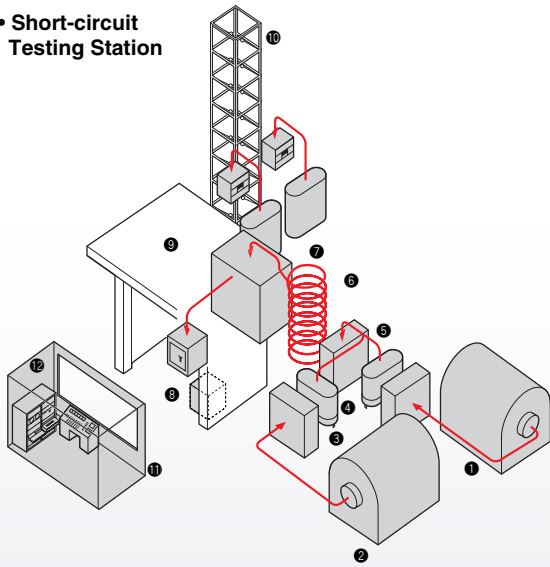

- 1 Short-circuit test generator No.1
- 2 Short-circuit test generator No.2
- 3 Voltage change device
- 4 Back-up breaker
- 5 Making switch
- 6 Reactors, Resistance
- 7 Step-down 3ø transformer
- 8 800V d.c. short-circuit testing equipment
- 9 Pit
- 10 Impulse generator
- 11 Control room
- 12 Computerized control equipment

Combined Short-circuit Capacity (MVA) When Two Short-circuit Test Generators (No.1 and No.2) are Paralleled.

Time after short-circuit (Cycle)	Sym. 3ø R.M.S.
0	1060
1/2	950
1	860
3	710



Short-circuit test generator No.1



Short-circuit test generator No.2



TYPE TESTS on every lot

- ★ Construction test
- ★ Operation test
- ★ Tripping test
- ★ Overload test
- ★ Overshooting test
- ★ Temperature rise test
- ★ Endurance test
- ★ Insulation resistance test
- ★ Withstand voltage test
- ★ Short-circuit test
- ★ Flexible cord protection test
- ★ Short-circuit making capacity test
- ★ Short-time withstand current test



RELIABILITY TESTS

- ★ Vibration test
- ★ Mechanical operation test
- ★ Rust proof test
- ★ Mechanical impact test
- ★ Heat-shock test
- ★ Gas proof test
- ★ Aging test

Appearance of major products

TemPower

Air Circuit Breakers □
with enhanced OCR



TemBreak

Moulded Case □
Circuit Breakers



Air Circuit Breakers

(AME series for □
Generator Protection)



Earth-leakage Relays



TemPlug

Direct bus plug-in □
mounting base



TemMeasure

Power Monitoring □
Equipment



1

Tempo

Air Circuit Breakers

AR Standard Series

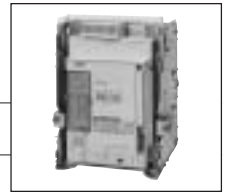

AMPERE RATING(A)		800	1250	1600	2000	2500	3200	4000	
TYPE		AR208S	AR212S	AR216S	AR220S	AR325S	AR332S	AR440S	
RATED CURRENT (max) [I_n](A) ① ②	IEC, EN, AS	800	1250	1600	2000	2500	3200	4000	
	JIS	800	1250	1600	2000	2500	3200	3700	
	NEMA, ANSI	800	1250	1540	2000	2500	3200	3700	
	Marine	800	1250	1600	2000	2500	3200	4000	
NEUTRAL POLE AMPERES FRAME (A)		800	1250	1600	2000	2500	3200	4000	
NUMBER OF POLES		③ ④		③ ④		③ ④		③ ④	
RATED PRIMARY CURRENT OF OVER-CURRENT RELEASE [I_{CT}](A)		200	400	400	400	2500	3200	4000	
• for general feeder circuit use		400	800	800	800				
		800	1250	1250	1250				
				1600	1600				
					2000				
RATED CURRENT OF OVER-CURRENT RELEASE (A)		100 ≤ I_n ≤ 200	200 ≤ I_n ≤ 400	200 ≤ I_n ≤ 400	200 ≤ I_n ≤ 400	1250 ≤ I_n ≤ 2500	1600 ≤ I_n ≤ 3200	2000 ≤ I_n ≤ 4000	
• for generator protection use		200 < I_n ≤ 400	400 < I_n ≤ 800	400 < I_n ≤ 800	400 < I_n ≤ 800				
[I_n] is generator rated current.		400 < I_n ≤ 800	630 < I_n ≤ 1250	630 < I_n ≤ 1250	630 < I_n ≤ 1250				
				800 < I_n ≤ 1600	800 < I_n ≤ 1600				
					1000 < I_n ≤ 2000				
AC RATED INSULATION VOLTAGE [U_i](V. 50/60Hz) ⑤		1000	1000	1000	1000	1000	1000	1000	
RATED OPERATIONAL VOLTAGE [U_e](V. 50/60Hz) ⑥		690	690	690	690	690	690	690	
AC RATED BREAKING CAP [kA sym rms]/MAKING CAP [kA peak]									
IEC,EN,AS		50/105	50/105	50/105	50/105	65/143	65/143	75/165	
[$I_{CS} = I_{CU}$]		65/143 ⑧	65/143 ⑧	65/143 ⑧	65/143 ⑧	85/187 ⑧	85/187 ⑧	100/220	
NEMA		42/96.6	42/96.6	42/96.6	42/96.6	50/115	50/115	65/149.5	
ANSI		50/115	50/115	50/115	50/115	65/149.5	65/149.5	75/172.5	
		65/149.5	65/149.5	65/149.5	65/149.5	85/195.5	85/195.5	100/230	
JIS		50/105	50/105	50/105	50/105	65/143	65/143	75/165	
		65/143	65/143	65/143	65/143	85/195.5	85/195.5	100/230	
		65/143	65/143	65/143	65/143	85/195.5	85/195.5	100/230	
⑨		40/40	40/40	40/40	40/40	40/40	40/40	40/40	
		40/40	40/40	40/40	40/40	40/40	40/40	40/40	
NK ⑫		50/115	50/115	50/115	50/115	65/153	65/153	75/179	
		65/153 ⑧	65/153 ⑧	65/153 ⑧	65/153 ⑧	85/201 ⑧	85/201 ⑧	100/245	
LR, AB, ⑫		50/115	50/115	50/115	50/115	65/153	65/153	75/179	
GL, BV		65/153 ⑧	65/153 ⑧	65/153 ⑧	65/153 ⑧	85/201 ⑧	85/201 ⑧	100/245	
RATED IMPULSE WITHSTAND VOLTAGE [U_{imp}](kV)		12	12	12	12	12	12	12	
RATED SHORT TIME WITHSTAND CURRENT [I_{cw}](kA rms)		65	65	65	65	85	85	100	
LATCHING CURRENT (kA)		50	50	50	50	65	65	85	
TOTAL BREAKING TIME (s)		65	65	65	65	85	85	100	
CLOSING OPERATION TIME		0.03	0.03	0.03	0.03	0.03	0.03	0.03	
SPRING CHARGING TIME (s) max.		10	10	10	10	10	10	10	
CLOSE TIME (s) max.		0.08	0.08	0.08	0.08	0.08	0.08	0.08	
No. of operating cycles									
Mechanical life with maintenance		30000	30000	30000	25000	20000	20000	15000	
without maintenance		15000	15000	15000	12000	10000	10000	8000	
Electrical life without maintenance AC460V		12000	12000	12000	10000	7000	7000	5000	
AC690V		10000	10000	10000	7000	5000	5000	2500	
WEIGHT (kg) draw-out type		73 86	73 86	76 90	79 94	105 125	105 125	139 176	
OUTLINE DIMENSION (mm)									
FIXED TYPE									
		a	a	a	a	a	a	—	
		360	445	360	445	360	445	466 586	
		460	460	460	460	460	460	460	
		290	290	290	290	290	290	—	
		75	75	75	75	75	75	—	
DRAW-OUT TYPE ⑬									
		a	a	a	a	a	a	a	
		354	439	354	439	354	439	460 580	
		460	460	460	460	460	460	460	
		345	345	345	345	345	345	345	
		40	40	40	40	40	40	631 801	
								460	
								375	
								53	

① : Values in open air at 40°C (45°C for marine applications).

② : Values of AR208S ~ 216S for draw-out type with horizontal terminals, Values of AR220S ~ 440S for draw-out type with vertical terminals.

③ : For 2poles use both opposite ends poles of 3poles ACBs.

④ : 4poles ACBs without Neutral phase protection can not be applied to IT earthing systems.

⑤ : Rated insulation voltage depends on applied standard: 1000V AC according to IEC 60947-2.

⑥ : Rated operational voltage depends on applied standard: 690V according to IEC 60947-2.

⑦ : Cannot apply IT earthing system, ie, insulated from earth.

⑧ : For 500V AC.

⑨ : Please contact TERASAKI for DC application.

⑩ : 3poles in series should be applied for 600V DC.

⑫ : Applicable to only 3poles ACBs.

⑬ : For vertical terminals or horizontal terminals.

1

TemPower

Air Circuit Breakers

AR High Fault Series

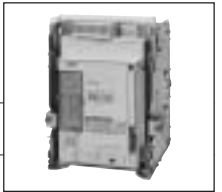

AMPERE RATING(A)	1250	1600	2000	1600	2000	2500	3200
TYPE	AR212H	AR216H	AR220H	AR316H	AR320H	AR325H	AR332H
RATED CURRENT (max) [I_n](A)	1250	1600	2000	1600	2000	2500	3200
① ②	1250	1600	2000	1600	2000	2500	3200
IEC, EN, AS	1250	1600	2000	1600	2000	2500	3200
JIS	1250	1600	2000	1600	2000	2500	3200
NEMA, ANSI	1250	1600	2000	1600	2000	2500	3200
Marine	1250	1600	2000	1600	2000	2500	3200
NEUTRAL POLE AMPERES FRAME (A)	1250	1600	2000	1600	2000	2500	3200
NUMBER OF POLES	3 4	3 4	3 4	3 4	3 4	3 4	3 4
RATED PRIMARY CURRENT OF OVER-CURRENT RELEASE [I_{CT}](A)	200	1600	2000	200	2000	2500	3200
• for general feeder circuit use	400			400			
	800			800			
	1250			1250			
				1600			
RATED CURRENT OF OVER-CURRENT RELEASE (A)	$100 \leq I_n \leq 200$	$800 \leq I_n \leq 1600$	$1000 \leq I_n \leq 2000$	$100 \leq I_n \leq 200$	$1000 \leq I_n \leq 2000$	$1250 \leq I_n \leq 2500$	$1600 \leq I_n \leq 3200$
• for generator protection use	$200 < I_n \leq 400$			$200 < I_n \leq 400$			
[I_n] is generator rated current.	$400 < I_n \leq 800$			$400 < I_n \leq 800$			
	$630 < I_n \leq 1250$			$630 < I_n \leq 1250$			
				$800 < I_n \leq 1600$			
AC RATED INSULATION VOLTAGE [U_i](V. 50/60Hz) ⑤	1000	1000	1000	1000	1000	1000	1000
RATED OPERATIONAL VOLTAGE [U_e](V. 50/60Hz) ⑥	690	690	690	690	690	690	690
AC RATED BREAKING CAP [kA sym rms]/MAKING CAP [kA peak]※							
IEC,EN,AS	AC 690V ⑦	55/121	55/121	55/121	85/187	85/187	85/187
[$I_{CS} = I_{CU}$]	440V	80/176	80/176	80/176	100/220	100/220	100/220
NEMA	AC 600V	42/96.6	42/96.6	42/96.6	50/115	50/115	50/115
ANSI	480V	55/127	55/127	55/127	80/184	80/184	80/184
	240V	80/184	80/184	80/184	100/230	100/230	100/230
JIS	AC 550V	55/121	55/121	55/121	85/196	85/196	85/196
	460V	80/176	80/176	80/176	100/230	100/230	100/230
	220V	80/176	80/176	80/176	100/230	100/230	100/230
⑨	DC 600V ⑩	40/40	40/40	40/40	40/40	40/40	40/40
	250V	40/40	40/40	40/40	40/40	40/40	40/40
NK ⑫	AC 690V	55/128	55/128	55/128	85/201	85/201	85/201
	450V	80/186	80/186	80/186	100/233	100/233	100/233
LR, AB, ⑫	AC 690V	55/128	55/128	55/128	85/201	85/201	85/201
GL, BV	450V	80/186	80/186	80/186	100/233	100/233	100/233
RATED IMPULSE WITHSTAND VOLTAGE [U_{imp}](kV)	12	12	12	12	12	12	12
RATED SHORT TIME WITHSTAND CURRENT [I_{cw}](kA rms)	1s	80	80	80	100	100	100
3s	55	55	55	75	75	75	75
LATCHING CURRENT (kA)	65	65	65	85	85	85	85
TOTAL BREAKING TIME (s)	0.03	0.03	0.03	0.03	0.03	0.03	0.03
CLOSING OPERATION TIME							
SPRING CHARGING TIME (s) max.	10	10	10	10	10	10	10
CLOSE TIME (s) max.	0.08	0.08	0.08	0.08	0.08	0.08	0.08
No. of operating cycles							
Mechanical life	with maintenance	30000	30000	30000	25000	20000	20000
	without maintenance	15000	15000	15000	12000	10000	10000
Electrical life	without maintenance AC460V	12000	12000	12000	10000	7000	7000
	AC690V	10000	10000	10000	7000	5000	5000
WEIGHT (kg) draw-out type	79 94	79 94	79 94	105 125	105 125	105 125	105 125
OUTLINE DIMENSION (mm)							
DRAW-OUT							
TYPE ⑬							
a	354 439	354 439	354 439	460 580	460 580	460 580	460 580
b	460	460	460	460	460	460	460
c	345	345	345	345	345	345	345
d	40	40	40	40	40	40	40

① : Values in open air at 40°C (45°C for marine applications).

② : Values for draw-out type with vertical terminals.

③ : For 2poles use both opposite ends poles of 3poles ACBs.

④ : 4poles ACBs without Neutral phase protection can not be applied to IT earthing systems.

⑤ : Rated insulation voltage depends on applied standard: 1000V AC according to IEC 60947-2.

⑥ : Rated operational voltage depends on applied standard: 690V according to IEC 60947-2.

⑦ : Contact TERASAKI for details.

⑨ : Please contact TERASAKI for DC application.

⑩ : 3poles in series should be applied for 600V DC.

⑫ : Applicable to only 3poles ACBs.

⑬ : For vertical terminals.

※ : When the ACB is used without Instantaneous trip function MCR should be set to work. The rated breaking capacity will reduce to the level of the latching current without MCR function.

1

Air Circuit Breakers AT-AH Series

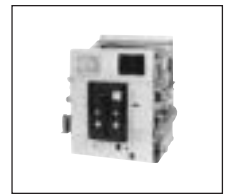
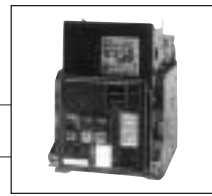

Frame Size (A)	2000	2500	4000	5000	6300				
Type	AT20L	AT25L	AH-40C	AH-50C	AH-60C				
■ RATED CURRENT [In] (A) (Max.) ①	IEC, BS, VDE, AS JIS JEC ⑩ NEMA, ANSI Marine	2000 2500 1700	2500 2500 4000 3650 4000	4000 4000 5000 4650 5000	5000 5000 6150 5300 6150	6300 6300 6150 5300 6150			
Neutral Pole Amperes Frame (A) ②	2000	2500	4000	5000	6000				
Number of Poles ③	2000 ⑥	2000 ⑧	3200	5000	6300				
■ RATED PRIMARY CURRENT OF OVER-CURRENT TRIP DEVICES [Icr] (A) • for general feeder circuit use	3 4 320 1600 630 2000 1250	3 4 2500	2,3 4 4000	2,3 4 5000	2,3 4 6300				
■ RATED CURRENT OF OVER-CURRENT TRIP DEVICES [Io] (A) • for generator protection use ([Io] is generator rated current)			1600 ≤ Io ≤ 4000	2000 ≤ Io ≤ 5000	2500 ≤ Io ≤ 6300				
AC Rated insulation voltage [Ui] (V) ④	690	690	1000	1000	1000				
Rated operational voltage [Ue] (V) ⑤	480	480	690	690	690				
■ AC RATED BREAKING CAP. (kA sym.)/MAKING CAP. (kA peak)									
IEC BS VDE AS [Ics]	with INST [Ics]=100%[Icu]	AC 690V ⑪ 600V ⑪ 500V		85/187 85/187 120/264 120/264	85/187 85/187 120/264 120/264	85/187 85/187 120/264 120/264			
	with MCR	AC 690V ⑪ 600V ⑪ Up to 500V	130/286	85/187 85/187 100/220 60/132 60/132	85/187 85/187 100/220 70/154 70/154	85/187 85/187 120/264 70/154 70/154			
NEMA ANSI	with INST	AC 600V 480V 240V		100/230 120/276 120/276	100/230 100/230 100/230	100/230 100/230 100/230			
	with MCR	AC 600V Up to 480V		100/230 100/230 60/138	100/230 100/230 70/161	100/230 100/230 70/161			
JIS	without INST	Up to AC 600V		100/230 60/132	100/230 70/154	100/230 70/154			
	with INST	AC 550V 460V 220V	130/325 130/325	100/230 100/230 100/230	100/230 100/230 100/300	100/230 100/230 120/300			
JEC	with MCR	AC 550V Up to 460V		100/230 100/230	100/230 100/230	100/230 100/300			
	without INST	Up to AC 550V		60/132 40/40	70/154 40/40	70/154 40/40			
NK	with INST only	DC 250V ⑦		40/40	40/40	40/40			
	with INST	AC 500V	130/322 ⑨	120/286 100/231	120/286 100/231	120/286 100/231			
AB	with MCR	AC 500V		100/231 60/138	100/231 70/153	120/286 70/153			
	without INST	AC 500V	130/322 ⑨	120/286 124/280 ⑫ 108/239	120/286 124/280 108/239	120/286 124/280 ⑬ 124/280			
LR	with INST	AC 500V		62.8/144	76.3/170	77.37/166			
	with MCR	AC 500V	130/322 ⑨	120/286 100/231	120/286 100/231	120/286 100/239			
BV	without INST	AC 500V							
	with INST	AC 500V		120/286	120/286	120/286			
GL	with MCR	AC 500V		100/231	100/231	100/239			
	without INST	AC 500V							
Rated impulse withstand voltage [Uimp] (kV)	8	8	8	8	8				
Utilization Category	A	A	B	B	B				
Rated short time withstand current rms [Icw] (kA)	17	17	100	100	120				
Latching current rms (kA)	17	17	70	70	70				
Total breaking time (s)	0.02	0.02	0.03	0.03	0.03				
Closing operation time									
Spring charging time (s) max.	10	10	10	10	10				
Close time (s) max.	0.06	0.06	0.04	0.04	0.04				
Weight (kg) draw-out type (Motor Charging)	91 115	152 188	240 280	350 450	380 480				
■ OUTLINE DIMENSION (mm)									
Fixed Type	a								
	b								
	c								
	d								
Draw-out Type	a	368 453	518 653	622 782	747 937	747 937			
	b	492	526	655	685	685			
	c	458	458	566	589	589			
	d	92	82	106	146	146			

NOTE — : "no" or "not available".

- ① Values in open air at 40°C (45°C for marine applications). ② Neutral current rating is equal to the max. applicable current rating, which varies depending on applicable standards. ③ 2-pole type is identical to 3-pole type except the centre pole is omitted. 4-poles type can not be applied to Marine approval. ④ 1000V.AC. according to IEC60947-2. ⑤ 690V.AC. according to IEC60947-2. ⑥ 1700A for JEC standard. ⑦ DC rating is of special application. ⑧ Full rated neutral pole available on request. ⑨ Values at 480V AC. ⑩ Ratings are the actual performance not the recommended values of the standard. ⑪ Cannot apply IT earthing system, ie, insulated from earth. ⑫ 86.1/203kA at 660V.AC. ⑬ 87.6/203kA at 660V.AC.

1

Air Circuit Breakers

AME Series for Generator protection

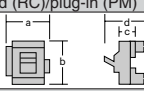
Frame Size [A]	250	400	630	800	1000
Type	AME3B	AME4B	AME6B	AME8B	AME10B
Number of poles	3	3	3	3	3
Rated current of overcurrent trip device [A] (I_n is generator rated current)	$16 \leq I_n \leq 31.5$ $31.5 < I_n \leq 63$ $63 < I_n \leq 125$ $125 < I_n \leq 250$	$200 \leq I_n \leq 400$	$315 \leq I_n \leq 630$	$500 \leq I_n \leq 800$	$800 \leq I_n \leq 1000$
Rated insulation voltage (U_i) [VAC]	600	600	600	600	600
Rated frequency [Hz]	50/60	50/60	50/60	50/60	50/60
AC RATED BREAKING CAPACITY [kA sym. rms.] /RATED MAKING CAPACITY [kA peak]					
LR, AB, GL, with INST	460V	460V	460V	460V	460V
BV, NK without INST	460V	460V	460V	460V	460V
Rated short-time current (Icw) [kA, rms.]	4 (150ms)	6 (150ms)	10 (150ms)	15 (150ms)	15 (150ms)
OPERATION					
Direct manual	•	•	•	•	•
External manual (option)	•	•	•	•	•
Motorized (option)	•	•	•	•	•
DIMENSIONS (mm)					
rear-connected (RC)/plug-in (PM)					
	a b c d	a b c d	a b c d	a b c d	a b c d
CONNECTIONS AND MOUNTINGS					
Rear connected	•	•	•	•	•
Flat bar stud	•	•	•	•	•
RC	•	•	•	•	•
Plug-in	•	•	•	•	•
For switchboard	•	•	•	•	•
PM	•	•	•	•	•
weight	6.5	6.5	10	19.5	19.5
Direct manual operation/(Rear connected)					
(kg)	8.2	8.2	16.1	30.1	30.1
Direct manual operation/(Plug-in)					
ACCESSORIES (option)					
Undervoltage trip	•	•	•	•	•
②	•	•	•	•	•
UTV	•	•	•	•	•
Shunt trip	•	•	•	•	•
②	•	•	•	•	•
SHT	•	•	•	•	•
Auxiliary switch	•	•	•	•	•
AX	•	•	•	•	•
③	•	•	•	•	•
Alarm switch	•	•	•	•	•
AL	•	•	•	•	•
Handle extension (For direct manual)	•	•	•	•	•
EHA	•	•	•	•	•
③	•	•	•	•	•
Terminal cover for rear connected • plug-in	•	•	•	•	•
TCR	•	•	•	•	•
OCR checker	•	•	•	•	•
④	•	•	•	•	•
OCR adapter	•	•	•	•	•
⑤	•	•	•	•	•
PROTECTIVE FUNCTIONS					
Electronic type	•	•	•	•	•
LTD • STD • INST	•	•	•	•	•
STD • INST	•	•	•	•	•
ENDURANCE					
Number of operations with current	2000	1000	500	500	500
Number of operations without current	8000	9000	4500	4500	4500

- NOTES:** • : Available. — : Not available.
 ① : With long time-delay trip and short time-delay trip.
 ② : Cannot use UVT and SHT jointly.
 ③ : Equipped as standard.
 ④ : Used for testing instantaneous trip function (separate mounting).
 NK standard requires at least one checker per vessel.
 ⑤ : Used for testing tripping characteristics with secondary current.



(Type AME 4B
Direct manual operation)



(Type AME 4B
Motorized operation)

2

TemBreak

1 Moulded Case Circuit Breakers

Standard XS Series

Frame Size [A]	30	50	50	60	100	225		
Type	XS30NB	XS50CB	XS50NB	XS60NS	XS100NB	XS225NS		
Number of Poles	2 3	2 3	2 3	2 3	2 3 4	3 4		
Outside view								
■ RATED CURRENT (In) [A] at 40°C (45°C for marine applications)	3 15 5 20 10 30	10 30 15 40 20 50	10 30 15 40 20 50	60	15 40 75 20 50 100 30 60	125 200 150 225 175		
Rated impulse withstand voltage (Uimp) [kV]	6	6	6	6	8	8		
Rated insulation voltage (Ui) [VAC]	660	660	660	660	690	690		
■ AC RATED BREAKING CAPACITY [kA sym. rms.]	1.5 2.5 5	5 7.5 10	7.5 10 25	7.5 10 25	15 25 50	22 25 50		
JIS C 8370	550V 460V 220V	500V 440V 415V 380V 240V	500V 440V 415V 380V 240V	500V 440V 415V 380V 240V	500V 440V 415V 380V 240V	500V 440V 415V 380V 240V		
IEC 60947-2	500V 440V 415V 380V 240V	500V 440V 415V 380V 240V	500V 440V 415V 380V 240V	500V 440V 415V 380V 240V	500V 440V 415V 380V 240V	500V 440V 415V 380V 240V		
BS EN 60947-2	500V 440V 415V 380V 240V	500V 440V 415V 380V 240V	500V 440V 415V 380V 240V	500V 440V 415V 380V 240V	500V 440V 415V 380V 240V	500V 440V 415V 380V 240V		
NEMA AB-1	600V 480V 240V	600V 480V 240V	600V 480V 240V	600V 480V 240V	600V 480V 240V	600V 480V 240V		
Without Inst.	240-690V	240-690V	240-690V	240-690V	240-690V	240-690V		
■ DC RATED BREAKING CAPACITY [kA] ①	250V 125V	250V 125V	250V 125V	250V 125V	250V 125V	250V 125V		
Rated short time current (Icw) [kA. rms.]	—	—	—	—	—	—		
Utilization Category	A	A	A	A	A	A		
■ DIMENSIONS (mm)								
	a 130 68 87	b 130 68 87	c 130 68 87	d 130 68 87	a 130 68 87	b 130 68 87	c 130 68 87	d 130 68 87
Weight (kg) ● marked standard type	0.48 0.74	0.48 0.74	0.48 0.74	0.48 0.74	0.78 1.1 1.4	1.85 2.4		
■ CONNECTIONS AND MOUNTINGS								
Front connect (FC)	Terminal screw Attached flat bar Solderless terminal (PWC)	Terminal screw Attached flat bar Solderless terminal (PWC)	Terminal screw Attached flat bar Solderless terminal (PWC)	Terminal screw Attached flat bar Solderless terminal (PWC)	Terminal screw Attached flat bar Solderless terminal (PWC)	Terminal screw Attached flat bar Solderless terminal (PWC)		
Rear connect (RC)	Bolt stud Flat bar stud	Bolt stud Flat bar stud	Bolt stud Flat bar stud	Bolt stud Flat bar stud	Bolt stud Flat bar stud	Bolt stud Flat bar stud		
Plug-in (PM)	For switchboard For distribution board	For switchboard For distribution board	For switchboard For distribution board	For switchboard For distribution board	For switchboard For distribution board	For switchboard For distribution board		
Draw-out (DO)	—	—	—	—	—	—		
■ PROTECTIVE FUNCTIONS								
Electronic type	Adjustable LTD, STD & INST. Adjustable GFT or Adjustable PTA (option) Trip Indicators (option)	Adjustable LTD, STD & INST. Adjustable GFT or Adjustable PTA (option) Trip Indicators (option)	Adjustable LTD, STD & INST. Adjustable GFT or Adjustable PTA (option) Trip Indicators (option)	Adjustable LTD, STD & INST. Adjustable GFT or Adjustable PTA (option) Trip Indicators (option)	Adjustable LTD, STD & INST. Adjustable GFT or Adjustable PTA (option) Trip Indicators (option)	Adjustable LTD, STD & INST. Adjustable GFT or Adjustable PTA (option) Trip Indicators (option)		
Thermal-magnetic type	Thermal and fixed magnetic trips Thermal and adjustable magnetic trips	Thermal and fixed magnetic trips Thermal and adjustable magnetic trips	Thermal and fixed magnetic trips Thermal and adjustable magnetic trips	Thermal and fixed magnetic trips Thermal and adjustable magnetic trips	Thermal and fixed magnetic trips Thermal and adjustable magnetic trips	Thermal and fixed magnetic trips Thermal and adjustable magnetic trips		
■ STANDARD FEATURES								
on-off colour indication	●	●	●	●	●	●		
Trip button	●	●	●	●	●	●		
■ ACCESSORIES (option)								
Internally mounted	Auxiliary switch AX, AXE Alarm switch AL, ALE Shunt trip SHT Undervoltage trip ⑨ UVT	Auxiliary switch AX, AXE Alarm switch AL, ALE Shunt trip SHT Undervoltage trip ⑨ UVT	Auxiliary switch AX, AXE Alarm switch AL, ALE Shunt trip SHT Undervoltage trip ⑨ UVT	Auxiliary switch AX, AXE Alarm switch AL, ALE Shunt trip SHT Undervoltage trip ⑨ UVT	Auxiliary switch AX, AXE Alarm switch AL, ALE Shunt trip SHT Undervoltage trip ⑨ UVT	Auxiliary switch AX, AXE Alarm switch AL, ALE Shunt trip SHT Undervoltage trip ⑨ UVT		
Externally mounted	Motor operator MOT External operating handle Panel mount. type OHE Breaker mount. type OHJ Variable depth type OHH Extension handle EHA Mechanical interlock Front type MIF Rear type MIB Handle holder HH Handle lock HL Terminal cover Front connect type TCF Rear / plug-in type TCR Interpole barrier TBA Accessory lead terminal ⑫LTF ⑬LTS Door flange D.F	Motor operator MOT External operating handle Panel mount. type OHE Breaker mount. type OHJ Variable depth type OHH Extension handle EHA Mechanical interlock Front type MIF Rear type MIB Handle holder HH Handle lock HL Terminal cover Front connect type TCF Rear / plug-in type TCR Interpole barrier TBA Accessory lead terminal ⑫LTF ⑬LTS Door flange D.F	Motor operator MOT External operating handle Panel mount. type OHE Breaker mount. type OHJ Variable depth type OHH Extension handle EHA Mechanical interlock Front type MIF Rear type MIB Handle holder HH Handle lock HL Terminal cover Front connect type TCF Rear / plug-in type TCR Interpole barrier TBA Accessory lead terminal ⑫LTF ⑬LTS Door flange D.F	Motor operator MOT External operating handle Panel mount. type OHE Breaker mount. type OHJ Variable depth type OHH Extension handle EHA Mechanical interlock Front type MIF Rear type MIB Handle holder HH Handle lock HL Terminal cover Front connect type TCF Rear / plug-in type TCR Interpole barrier TBA Accessory lead terminal ⑫LTF ⑬LTS Door flange D.F	Motor operator MOT External operating handle Panel mount. type OHE Breaker mount. type OHJ Variable depth type OHH Extension handle EHA Mechanical interlock Front type MIF Rear type MIB Handle holder HH Handle lock HL Terminal cover Front connect type TCF Rear / plug-in type TCR Interpole barrier TBA Accessory lead terminal ⑫LTF ⑬LTS Door flange D.F	Motor operator MOT External operating handle Panel mount. type OHE Breaker mount. type OHJ Variable depth type OHH Extension handle EHA Mechanical interlock Front type MIF Rear type MIB Handle holder HH Handle lock HL Terminal cover Front connect type TCF Rear / plug-in type TCR Interpole barrier TBA Accessory lead terminal ⑫LTF ⑬LTS Door flange D.F		

NOTES: ● : Standard. This configuration used unless otherwise specified.
○ : Optional standard. Specify when ordering.
● : "yes" or "available".
— : "no" or "not available".
① : DC rating available on request.
③ : Comes with conductor pressing terminal.

⑦ : Hydraulic-magnetic type for below 10A rating.
⑨ : The UVT controller is installed externally, when provided with AC UVT.
⑫ : Line side interpole barriers are supplied as standard.
⑬ : Draw out leads horizontally.
⑭ : Draw out leads vertically.
⑮ : The application on IT systems on this voltage is not available.

2

TemBreak

1 Moulded Case Circuit Breakers

Standard XS Series

Frame Size [A]	
Type	
Number of Poles	
Outside view	

■ RATED CURRENT (In) [A] at 40°C (45°C for marine applications)	
Rated impulse withstand voltage (Uimp) [kV]	
Rated insulation voltage (Ui) [VAC]	
■ AC RATED BREAKING CAPACITY [kA sym. rms.]	
JIS C 8370	550V 460V 220V
IEC 60947-2	lcu/lcs 690V 500V
BS EN 60947-2	440V 415V 380V
NEMA AB-1	240V 600V 480V 240V
Without Inst.	240-690V
■ DC RATED BREAKING CAPACITY [kA] ①	250V 125V
Rated short time current (Icw) [kA. rms.]	
Utilization Category	

■ DIMENSIONS (mm)	
	a b c d

Weight (kg) ● marked standard type	
■ CONNECTIONS AND MOUNTINGS	
Front connect (FC)	Terminal screw Attached flat bar Solderless terminal (PWC)
Rear connect (RC)	Bolt stud Flat bar stud
Plug-in (PM)	For switchboard For distribution board
Draw-out (DO)	

■ PROTECTIVE FUNCTIONS	
Electronic type	Adjustable LTD, STD & INST. Adjustable GFT or Adjustable PTA (option) Trip Indicators (option)
Thermal-magnetic type	Thermal and fixed magnetic trips Thermal and adjustable magnetic trips

■ STANDARD FEATURES	
on-off colour indication	
Trip button	
■ ACCESSORIES (option)	CODE
Internally mounted	Auxiliary switch AX, AXE Alarm switch AL, ALE Shunt trip SHT Undervoltage trip ⑨ UVT
Externally mounted	Motor operator MOT External operating handle Panel mount. type OHE Breaker mount. type OHJ Variable depth type OHH Extension handle EHA Mechanical interlock Front type MIF Rear type MIB Handle holder HH Handle lock HL Terminal cover Front connect type TCF Rear / plug-in type TCR Interpole barrier TBA Accessory lead terminal ⑫LTF ⑬LTS Door flange D.F.







400	400	400	600	600	600	800	800
XS400CS	XS400NS	XS400NE	XS600CS	XS600NS	XS600NE	XS800CS	XS800NS
3	4	3	4	3	4	3	4
125 200 300	125 200 300	Adjustable 125 200: 200 300	300 600	300 600	Adjustable 300 500	700	700
150 225 350	150 225 350	150 225: 225 350	400	400	350 600	800	800
175 250 400	175 250 400	175 : 250 400	500	500	400		
8	8	8	8	8	8	8	8
690	690	690	690	690	690	690	690
22	35	35	25	35	35	25	35
30	50	50	35	50	50	35	50
50	85	85	50	85	85	50	85
16/8 ⑳	18/9 ㉔	18/9 ㉔	16/8 ㉔	20/10 ㉔	20/10 ㉔	16/8 ㉔	20/10 ㉔
22/11 ㉔	30/15 ㉔	30/15 ㉔	25/13 ㉔	35/18 ㉔	35/18 ㉔	25/13 ㉔	35/18 ㉔
30/15	42/21	42/21	30/15	50/25	50/25	30/15	50/25
35/18	50/25	50/25	35/18	50/25	50/25	35/18	50/25
35/18	50/25	50/25	45/23	65/33	65/33	45/23	65/33
50/25	85/43	85/43	50/25	85/43	85/43	50/25	85/43
22	30	30	25	35	35	25	30
30	42	42	35	50	50	35	50
50	85	85	50	85	85	50	85
—	—	5	—	—	10	—	—
40	40	—	40	40	—	40	40
40	40	—	40	40	—	40	40
—	—	5 (0.3sec)	—	—	10 (0.3sec)	—	—
A	A	B	A	A	B	A	A
140 185	140 185	140 185	210 280	210 280	210 280	210 280	210 280
260	260	260	273	273	273	273	273
103	103	103	103	103	103	103	103
131	131	131	145	145	145	145	145
4.7 6.1	4.7 6.1	4.8 6.2	9.0 11.5	9.0 11.5	9.6 12.0	9.4 12.2	9.4 12.2
●	●	●	●	●	●	●	●
○ (BAR)	○ (BAR)	○ (BAR)	●	○	●	○	○
○	○	○	○	○	○	○	○
○	○	○	○	○	○	○	○
○ ⑬	○ ⑬	○ ⑬	○ ⑬	○ ⑬	○ ⑬	○ ⑬	○ ⑬
—	—	●	—	—	●	—	—
—	—	● (PTA only)	—	—	●	—	—
—	—	—	—	—	—	—	—
●	●	—	●	●	—	●	●
●	●	—	●	●	—	●	●
● (AX)	● (AX)	● (AX)	● (AX)	● (AX)	● (AX)	● (AX)	● (AX)
● (AL)	● (AL)	● (AL)	● (AL)	● (AL)	● (AL)	● (AL)	● (AL)
●	●	●	●	●	●	●	●
●	●	●	●	●	●	●	●
●	●	●	●	●	●	●	●
●	●	●	●	●	●	●	●
●	●	●	●	●	●	●	●
●	●	●	●	●	●	●	●
●	●	●	●	●	●	●	●
●	●	●	●	●	●	●	●
●	●	●	●	●	●	●	●
●	●	●	●	●	●	●	●
● ⑫	● ⑫	● ⑫	●	●	●	●	●
●	●	●	●	●	●	●	●
●	●	●	●	●	●	●	●
●	●	●	●	●	●	●	●

NOTES: ● : Standard. This configuration used unless otherwise specified.
○ : Optional standard. Specify when ordering.
● : "yes" or "available".
— : "no" or "not available".
① : DC rating available on request.
⑨ : The UVT controller is installed externally, when provided with AC UVT.
⑫ : Line side interpole barriers are supplied as standard.
⑬ : Special specification.
㉔ : Draw out leads horizontally.
㉔ : Draw out leads vertically.
㉔ : The application on IT systems on this voltage is not available.

2

1 Moulded Case Circuit Breakers

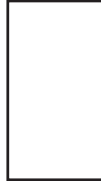
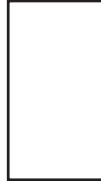
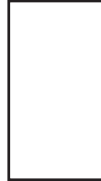
TO/TT Series

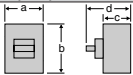
Frame Size [A]	3200	3200	4000						
Type	TO-3200	TT-3200	TO-4000						
Number of Poles	3	3	3						
Outside view									
Utilization Category	A	B	A						
■ RATED CURRENT (In) [A] at 40°C (45°C for marine applications)	2500 2800 3200	2500 2800 3200	4000						
Rated insulation voltage (Ui) [VAC]	690	690	690						
■ AC RATED BREAKING CAPACITY [kA sym. rms.] JIS C 8370	65 85 130	65 85 130	65 85 130						
IEC 60947-2	45/34 65/49 85/64	45/42 65/49 85/64	45/34 65/49 85/64						
BS EN 60947-2	85/64 100/75 130/98	85/64 100/75 130/98	85/64 100/75 130/98						
NEMA AB-1	65 85 130	65 85 130	65 85 130						
Without Inst.	240-690V	42	130						
■ DC RATED BREAKING CAPACITY [kA] ①	40 40	— —	40 40						
Rated impulse withstand voltage (Uimp) [kV]	8	8	8						
Rated short time current (Icw) [kA. rms.]	—	42 (0.3sec)	—						
■ DIMENSIONS (mm)									
	a b c d								
Weight (kg) ● marked standard type	390 560 235 315 120	390 560 235 315 120	390 560 235 315 120						
■ CONNECTIONS AND MOUNTINGS									
Front connect (FC)	Terminal screw Attached flat bar Solderless terminal (PWC)								
Rear connect (RC)	Bolt stud Flat bar stud								
Plug-in (PM)	For switchboard For distribution board								
Draw-out (DO)	○	○	—						
■ PROTECTIVE FUNCTIONS									
Electronic type	Adjustable LTD, STD & INST. Adjustable GFT or Adjustable PTA (option) Trip Indicators (option)								
Thermal-magnetic type	Thermal and fixed magnetic trips Thermal and adjustable magnetic trips	● (with Adj. STD)	●						
■ STANDARD FEATURES									
on-off colour indication	—	—	—						
Trip button	—	—	—						
■ ACCESSORIES (option)									
Internally mounted	Auxiliary switch AX, AXE Alarm switch AL, ALE Shunt trip SHT Undervoltage trip ② UVT	● (AX) ● (AL) ● ●	● (AX) ● (AL) ● ●	● (AX) ● (AL) ● ●					
Externally mounted	Motor operator MOT External operating handle Panel mount. type OHE Breaker mount. type OHJ Variable depth type OHH Extension handle EHA Mechanical interlock Front type MIF Rear type MIB Handle holder HH Handle lock HL Terminal cover Front connect type TCF Rear / plug-in type TCR Interpole barrier TBA Accessory lead terminal ③LTF ③LTS Door flange D.F	● ● ● ● ● ● ①⑥ ● ● ● ● (TYD) ●	● ● ● ● ● ● ● ①⑥ ● ● ● (TYD) ●	● ● ● ● ● ● ● ● ● (TYD) ●					

NOTES: ● : Standard. This configuration is used unless otherwise specified.
○ : Optional standard. Specify when ordering.
● : "yes" or "available".
— : "no" or "not available".
① : DC rating available on request.

①③ : Special specification.
①⑤ : Specify rated frequency, 50 or 60Hz.
①⑥ : Available on request, contact TERASAKI for details.
② : Draw out leads horizontally.
③ : Draw out leads vertically.

2

TemBreak

1 Moulded Case Circuit Breakers

Adjustable Thermal Trip

Frame Size [A]
Type
Number of Poles

Outside view

NOTE: *2 pole breaker is 3 pole breaker with centre pole omitted.

RATED CURRENT (In) [A]

at 45°C

Rated impulse withstand voltage (Uimp) [kV]

Rated insulation voltage (Ui) [VAC]

AC RATED BREAKING CAPACITY [kA sym. rms.]

IEC 60947-2

BS EN 60947-2

NEMA AB-1

Without Inst.

DC RATED BREAKING CAPACITY [kA] ①

Rated short time current (Icw) [kA. rms.]

Utilization Category

DIMENSIONS (mm)

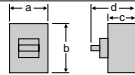

Weight (kg) ● Marked standard type

CONNECTIONS AND MOUNTINGS

Front connect (FC)	Terminal screw
	Attached flat bar
	Solderless terminal (PWC)
Rear connect (RC)	Bolt stud
	Flat bar stud
Plug-in (PM)	For switchboard
	For distribution board

Draw-out (DO)

PROTECTIVE FUNCTIONS

Adjustable thermal and fixed magnetic trips

Adjustable thermal and magnetic trips

STANDARD FEATURES

on-off color indication

Trip button

ACCESSORIES (option)

		CODE	
Internally mounted	Auxiliary switch	AX, AXE	
	Alarm switch	AL, ALE	
	Shunt trip	SHT	
	Undervoltage trip ⑨	UVT	
	Motor operator	MOT	
Externally mounted	External operating handle	Panel mount. type OHE Breaker mount. type OHJ Variable depth type OHH	
	Extension handle	EHA	
	Mechanical interlock	Front type	MIF
		Rear type	MIB
	Handle holder	HH	
	Handle lock	HL	
	Terminal cover	Front connect type	TCF
		Rear / plug-in type	TCR
	Interpole barrier	TBA	
	Accessory lead terminal	②LTF ③LTS	
	Door flange	D.F	
	IP20 protection	Plug-in type IP20	

630 XS630NJ		800 XS800NJ		125 XH125NJ		160 XH160NJ		250 XH250NJ				
*3	4	*3	4	*3	4	*3	4	*3	4			
Rated Curr.	Adj. range min. max.	Rated Curr.	Adj. range min. max.	Rated Curr.	Adj. range min. max.	Rated Curr.	Adj. range min. max.	Rated Curr.	Adj. range min. max.			
630	400 630	800	500 800	20	12.5 20	160	100 160	160	100 160			
				32	20 32			250	160 250			
				50	32 50							
				63	40 63							
				100	63 100							
				125	80 125							
8		8		8		8		8				
690		690		690		690		690				
20/10 ⑳		20/10 ⑳		8/4 ㉑		15/7.5 ㉒		15/7.5 ㉒				
35/18 ㉓		35/18 ㉓		25/13 ㉔		25/13 ㉔		25/13 ㉔				
50/25		50/25		42/21		42/21		42/21				
50/25		50/25		50/25		50/25		50/25				
65/33		65/33		50/25		50/25		50/25				
65/33		65/33		50/25		50/25		50/25				
85/43		85/43		85/43		85/43		85/43				
30		30		25		25		25				
50		50		42		42		42				
85		85		85		85		85				
—		—		—		—		—				
40		40		40		40		40				
40		40		40		40		40				
—		—		—		—		—				
A		A		A		A		A				
210	280	210	280	90	120	105	140	105	140			
273		273		155		165		165				
103		103		86		103		103				
145		145		104		124		124				
9.0	11.5	9.4	12.2	1.3	1.58	2.1	2.6	2.1	2.6			

NOTES: ● : Standard. This configuration used unless otherwise specified.

○ : Optional standard. Specify when ordering.

● : "yes" or "available".

— : "no" or "not available".

① : D C rating available on request.

⑨ : The UVT controller is installed externally when provided with AC UVT.

㉒ : Draw out leads horizontally

㉓ : Draw out leads vertically

㉔ : The application on IT systems on this voltage is not available.

Approvals and Applicable Breaking Capacities to Marine Standards.

Breaker type	Rated current[A]	Poles	Rated voltage [V]	AC Rated breaking capacity [kA sym. rms.] /Rated making capacity [kA peak]					DC Rated breaking capacity [kA]														
				NK	LR	AB	GL	BV	NK	LR	AB	GL	BV										
XH800PS	700,800	3	460	85/193	85/193	85/193	85/187 ^①																
XS1200NE	200~400,400~800, 600~1200 {200,225,250,300,350,400,450 500,600,700,800,1000,1200}	3	500	50/117 ^①	53.5/125 ^①	50/117 ^①	65/143 ^{①②}	65/143 ^{①②}															
			250	85/198 ^①	88.8/204 ^①	85/198 ^①	100/220 ^{①②}																
			500	15/31.3 ^②	15.4/31.4 ^②	15/31.3 ^②																	
			250	15/31.3 ^②	15.4/31.4 ^②	15/31.3 ^②																	
XS1600NE	800~1600 {800,900,1000, 1200,1400,1600}	3	500	85/196 ^①	87.1/194.9 ^①	85/196 ^①	85/187 ^{①②}																
			500	20/46 ^②	21.5/51.5 ^②	20/46 ^②																	
XS2000NE	1200~2000 {1200,1400,1600 1800,2000}	3	500	85/195 ^①	87.1/194.9 ^①	85/195 ^①	85/187 ^{①②}																
			500	42/99 ^②	43.0/102.9 ^②	42/99 ^②																	
XM30NB	0.7,1.4,2.2,6,4,5, 8,10,12,16,25,32	3	500	2.5/3.8	2.5/3.8	2.5/3.8																	
			250	5/8.7	5/8.7	5/8.7																	
XM50CB	0.7,1.4,2.2,6,4,5,8,10, 12,16,25,32,40,45	3	500	2.5/3.8	2.5/3.8	2.5/3.8																	
			250	5/8.7	5/8.7	5/8.7																	
TB-5D	10,15,20,30,40 50	2	250	5/8.0 ^⑦	5/8.0 ^⑦	5/8.0 ^⑦	5/7.98 ^{④⑩}	5/8.0 ^{⑦⑨}															
			125	42/99.3	43.5/101.6	42/99.3	42/102 ^⑧	7.5/13.7 ^⑧															
TB-5S	10,15,20,30,40 50	2	250	5/8.0 ^⑦	5/8.0 ^⑦		5/7.98 ^{④⑩}																
			125	42/99.3	43.5/101.6		42/102 ^⑧																
TB-5P	10,15,20,30,40 50	2	250	5/8.0 ^⑦	5/8.0 ^⑦	5/8.0 ^⑦	5/7.98 ^{④⑩}	5/8.0 ^{⑦⑨}															
			125	42/99.3	43.5/101.6	42/99.3	42/102 ^⑧	7.5/13.7 ^⑧															
TL-100F	15,20,30,40,50 60,75,100	3	460	120/280	120/280	120/280	120/288 ^①	120/280 ^⑩															
			460	120/280	120/280	120/280	120/288 ^①	120/280 ^⑩															
TL-225F	125,150,175,200, 225	3	460	120/280	120/280	120/280	120/288 ^①	120/280 ^⑩															
			460	120/280	120/280	120/280	120/288 ^①	120/280 ^⑩															
TL-400E	250,300,350,400	3	460	120/280	120/280	120/280	120/288 ^①	120/280 ^⑩															
			690	—	—	—	45/92 ^⑩	45/94.5 ^⑩															
			460	125/295	125/295	125/295	125/298 ^①	125/275 ^①															
TL-600NE	300~600 {300,350,400, 500,600}	3	460	—	—	—	150/347 ^⑩	150/330 ^⑩															
			240	—	—	—	45/92 ^⑩	45/94.5 ^⑩															
			690	125/295	125/295	125/295	125/298 ^①	125/275 ^①															
TL-800NE	400~800 {400,450,500, 600,700,800}	3	460	—	—	—	150/347 ^⑩	150/330 ^⑩															
			240	—	—	—	45/92 ^⑩	45/94.5 ^⑩															
			690	125/295	125/295	125/295	125/298 ^①	125/275 ^①															
TL-1000NE	500~1000 {500,600,700, 800,900,1000}	3	690	—	45/93.8 ^⑩	—	45/92 ^⑩	45/94.5 ^⑩															
			460	125/295	125/295 ^①	125/295	125/298 ^①	125/275 ^①															
			240	—	150/345 ^⑩	—	150/347 ^⑩	150/330 ^⑩															
TL-1200NE	600~1200 {600,700,800, 1000,1200}	3	690	—	45/93.8 ^⑩	—	45/92 ^⑩	45/94.5 ^⑩															
			460	125/295	125/295 ^①	125/295	125/298 ^①	125/275 ^①															
			240	—	150/345 ^⑩	—	150/347 ^⑩	150/330 ^⑩															
TL-100C	15,20,30,40,50, 60,75,100	3	500	180/396	180/419 ^{⑥⑪}	180/396	180/419 ^①	180/415 ^⑩															
			500	180/396	180/419 ^{⑥⑪}	180/396	180/419 ^①	180/415 ^⑩															
TL-225B	125,150,175,200, 225	3	500	180/396	180/419 ^{⑥⑪}	180/396	180/419 ^①	180/415 ^⑩															
			250	180/396	180/419 ^{⑥⑪}	180/396	180/419 ^①	180/415 ^⑩															
TL-400	125,150,175,200,225, 250,300,350,400	3	500	180/396	180/419 ^{⑥⑪}	180/396	180/419 ^①	180/415 ^⑩															
			250	180/396	180/419 ^{⑥⑪}	180/396	180/419 ^①	180/415 ^⑩															
TL-600	450,500,600	3	500	180/396	180/419 ^{⑥⑪}	180/396	180/419 ^①	180/415 ^⑩															
			250	180/396	180/419 ^{⑥⑪}	180/396	180/419 ^①	180/415 ^⑩															
TL-800	700,800	3	500	180/396	180/419 ^{⑥⑪}	180/396	180/419 ^①	180/415 ^⑩															
			250	180/396	180/419 ^{⑥⑪}	180/396	180/419 ^①	180/415 ^⑩															

- NOTES: ① : with INST
 ② : without INST
 ③ : at 450V AC
 ④ : at 220V AC
 ⑤ : 50/116kA at 660V AC
 ⑥ : 50/115kA at 690V AC
 ⑦ : 2.5/4.1kA for 10A rating
 ⑧ : at 110V AC
 ⑨ : at 225V AC
 ⑩ : at 250V DC
 ⑪ : The value is Icu at 450V AC. Contact Terasaki for Ics value.
 ⑫ : at 240V AC
 ⑬ : Being or will be applied
 ⑭ : The value is Icu
 ⑮ : Contact Terasaki for Ics value.
 ⑯ : 2.5/3.57kA for 10A rating.

2

2 Earth-leakage Relays

TZS Series

Ratings of Relays

Type	
Phase and wires	3ø3W, 1ø2W 3ø4W

Outside view

TZS-AD

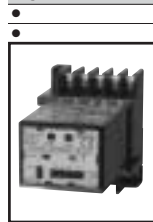

■ RATINGS

Rated control voltage [V AC]	50/60Hz
Applicable range	120V AC 240V AC
Rated sensitivity current [mA]	30 100 300 500 1000

Rated operating time (sec)

Rated operating time (sec)	below 0.04 0.3 0.5 1 2
----------------------------	------------------------------------

Dimensions [mm] (surface mount) W/H/D	60/78/100
Weight [kg] (surface mount)	0.22

■ MOUNTING

Surface mount	●
Flush mount	●

■ STANDARD FEATURES

Earth leakage detection	⑤
Output contact	1C ⑥
Earth leakage indication	LED (Red)
Reset function	electrical ⑦
Power source required	1VA

120 ①②
240
96-132
192-264
30
100
300 ③
500
1000
below 0.04
0.3
0.5 ③④
1
2
60/78/100
0.22
●
●
⑤
1C ⑥
LED (Red)
electrical ⑦
1VA

NOTE ● : Standard, this configuration is used unless otherwise specified.
● : "yes" or "available".

① : Terminals for 120V AC and 240V AC are provided.

CAUTION : DO NOT APPLY 240V AC TO THE 120V AC TERMINAL., BURNOUT CAN RESULT.

② : For 415V AC or 440V AC, Please contact to TERASAKI.

③ : Adjustable type by Dip slide swch.

④ : Operating time range and Non-operating time range.

Rated operating time (sec)	Operating time range (sec)	Non-operating time range (sec)
0.3	0.2~0.36	0.15
0.5	0.4~0.6	0.38
1	0.8~1.2	0.7
2	1.3~2	1.25

⑤ : Solid-state type, current operating type.

⑥ : Ratings of output contact.

	Resistance load cos φ= 1	Inductive load cos φ= 0.4 (L/R=7ms)	Min. load
120V AC	6A	3.5A	10mA at 5V DC
240V AC	6A	3.5A	
30V DC	6A	3A	

⑦ : The output contacts remain until the RESET button is operated.
Provided the control power supply fails the contacts automatically reset.

Ratings of ZCT (Core Balanced Current Transformers)

Type	
Outside view	

Diameter of transit part [mm]	
Weight [kg]	
Applicable numbers, size and continuous current of wires (IV cable wires)	
2 wires	max. continuous current max. wire size max.diameter of wire
3 wires	max. continuous current max. wire size max.diameter of wire
4 wires	max. continuous current max. wire size max.diameter of wire

	TZS-15	TZS-24	TZS-40	TZS-68	TZS-100	
Diameter of transit part [mm]	ø15	ø24	ø40	ø68	ø100	
Weight [kg]	0.2	0.3	0.7	1.1	2.0	
2 wires	61A 8mm ² 6mm	139A 30mm ² 10.5mm	298A 100mm ² 17mm	650A 325mm ² 29mm	1185A 850mm ² 45mm	
3 wires	61A 8mm ² 6mm	139A 30mm ² 10.5mm	298A 100mm ² 17mm	650A 325mm ² 29mm	1185A 850mm ² 45mm	
4 wires	49A 5.5mm ² 5mm	115A 22mm ² 9.5mm	257A 80mm ² 15.5mm	556A 250mm ² 26mm	992A 600mm ² 38mm	

3

TemMeasure Power Monitoring Equipment

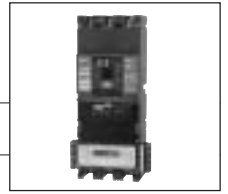

To protect the world's ecology, Terasaki addresses ourselves to energy saving and minimization of environmental pollution. *TemMeasure* allows power consumption to be monitored for each branch circuit, assisting you in saving energy. Features of *TemMeasure* include the following:

- Current, voltage, instantaneous power, integrated power, and power factor of low-voltage power distribution systems can be measured and displayed.
- Easy-to-use membrane switches and a clear 6-digit LED display, with a wide viewing angle.
- Applicable both to 3-phase and single-phase circuits.
- A cable extension permits separation between the display unit and the sensor unit and therefore installation of the display unit anywhere.
- Field fittable to the load side of the existing TemBreak range, MCCB 400AF, 600AF, 800AF.
- RS-485 serial transmission or pulse output of measured values is available.

Types		XBA3	XBA4	XBA6	XBA8
Applicable breaker		XE400NS, XS400CS, XS400NS, XH225NE, XS400NE, XH400NE		XS600NE XH600NE	XS800NE XH800NE
Phase and wire	3 ϕ 3 W	•	•	•	•
	1 ϕ 3 W	•	•	•	•
■ Ratings					
Main circuit voltage [V AC] ①		460			
Rated measuring current [A]		250	400	600	800
Rated frequency [Hz]		50/60Hz			
Control power	Internal ②③	Control power is supplied from the AC240 – 100V main circuit.			
	External ④⑤	When control power is AC240 – 100V, the device can be applied to the AC460 – 100V main circuit.			
■ Measuring and Display					
Load current of R/S/T phase ⑦	Range	2 – 300% of rated measuring current			
	accuracy ⑥	$\pm 1\%$ of rated measuring current			
Line voltage of between R/S/T phases	Range	AC100 – 460V			
	accuracy ⑥	$\pm 1\%$ of rated voltage			
Instantaneous power	Range	0 – 999999kW			
	accuracy ⑥	$\pm 2.5\%$			
Integrated power	Range	Max. 99999.9kWh or 99999.9MWh			
	accuracy ⑥	$\pm 2.5\%$ ⑧			
Power factor	Range	1 – 100% ⑨			
	accuracy ⑥	$\pm 2.5\%$			

NOTES: • : "yes" or "available".

① : Do not perform a dielectric strength test between poles. Doing so may cause damage to the internal VT or CT.

② : When the breaker is OFF or tripped, control power is lost, resulting in the measuring, display and transmission functions being disabled. Stored data including setting data and integrated power, however, are preserved.

③ : Not available for Display separate type.

④ : When control power is lost, integrated power is not measured and not integrated.

⑤ : A lead terminal block is fitted. An external transformer with a capacity of 30 VA or more is needed, because of inrush current occurring at control power ON.

⑥ : When the ambient temperature is 25°C

⑦ : The device reads 0 for less than 2%.

⑧ : Integrated time error: 0.01% ± 1 sec.

⑨ : If current is 0A, the device reads "FF".

Add-on type



Display separate type

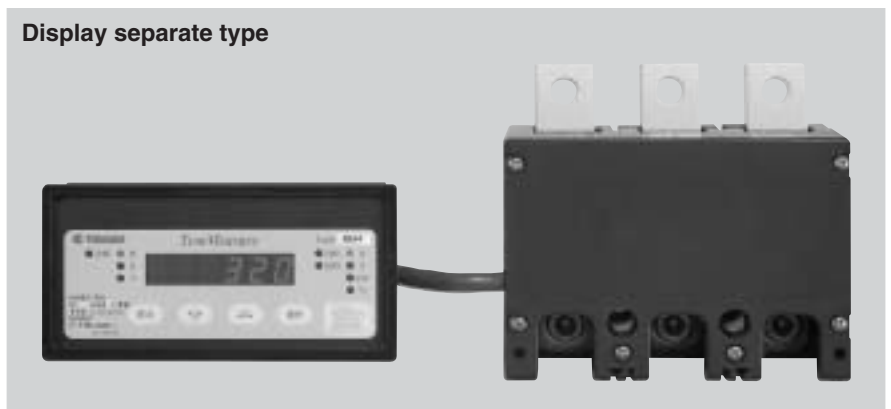

4

TemPlug

Direct bus plug-in mounting base

Just plug the *TemPlug* into the main bus.

That completes the connection!

We offer solutions to downsizing and standardizing them, shortening the manufacturing periods, and reducing the costs.

■ Downsizing of switchboards

The TemPlug is inserted directly into the main bus, requiring no space for branched bus bars. This allows for decreasing the width of a switchboard.

■ Standardization of switchboards

The size of the main bus is determined by the power capacity. Therefore, the switchboards of the same capacity can be standardized.

■ Shortening of manufacturing periods

The time-consuming jobs for making and mounting branched bus bars are no longer required.

The working time can be greatly saved, resulting in shorter lead-time of a switchboard.

■ Flexibility in changing specification

If there is any change in the frame size or rated current of a breaker, you can comply with that change by merely changing the TemPlug.

■ Standardization of order of phases

The order of load-side phases can be standardized into R, S, and T from the top regardless of the mounting orientation of the breaker.

■ Improvement of safety by separating sections

The use of the TemPlug allows you to separate the bus and breaker sections to manufacture a safer switchboard.

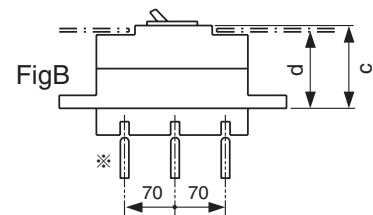
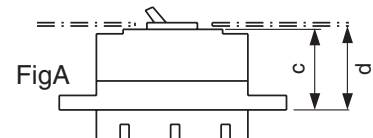
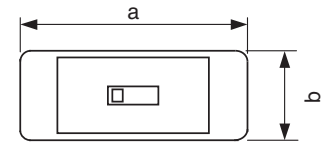
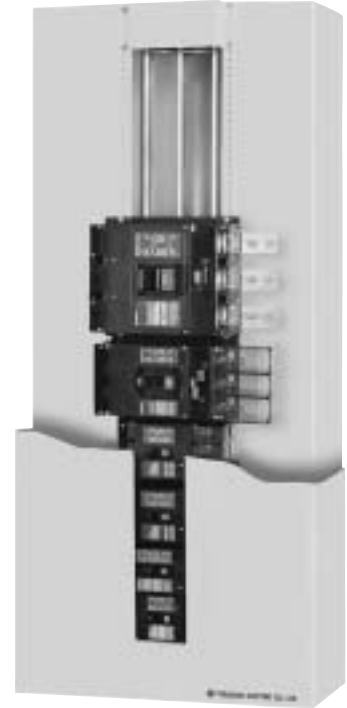

Applicable to 100A to 630A frame circuit breakers



100/125A

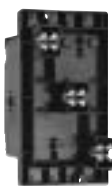

225/250A



400A

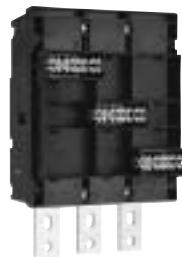

600/630A

Type	XDI2S	XDI2H	XDI3S	XDI3SZ	XDI3H	XDI4	XDI5
Frame size (A)	100	125	250	225	250	400	630
Applicable circuit breakers	XS100NB, XS100NNB, TZ100NB	XH100NS, XS125CJ, XS125NJ, XH125NJ	XS225NS, XS160NJ, XS250NJ, XS225NN	TZ225NB	XH225NS, XH160NJ, XS250PJ, XH250NJ	XE400NS, XS400CS, XS400NS, XS400NE, XH225NE, XH400NE, XS400CJ, XS400NJ, XS400NN	XE600NS, XS600CS, XS600NS, XS600NE, XH600NE, XS630CJ, XS630NJ
Dimensions	a	230				272	287
	b	90	120			180	240
	c	127 (Fig. B)	124 (Fig. A)				122 (Fig. A)
	d	125					

※Supply the round-edge type main bus with plate thickness of 10 mm and corner radius of 5 mm. Suitable for 70mm main bus pitch.

5

TemDin Miniature Circuit Breakers

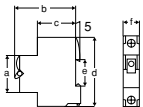
Ampere Frame		63					63					63					
Series		E-Series					S-Series					R-Series					
Number of poles		1	2	3	4	1	2	3	4	1	2	3	4	1	2	3	4
AC RATED INSULATION VOLTAGE [U_i]		415					415					415					
AC BREAKING CAPACITY sym. r.m.s.(kA)		③ 4.5/4.5					③ 6/6					10/7.5					
EN 60 898 [I _{cn}]/[I _{cs}]		—					10/6					10/7.5					
EN 60 947-2 [I _{cu}]/[I _{cs}]		—					—					—					
MCB Characteristics ②		—					—					—					
EN 60 898		0.5A					—					—					
Type TDB		—					—					—					
Characteristics: B		—					—					—					
④		—					—					—					
		1A					●					●					
		2A					—					—					
		3A					—					—					
		4A					—					—					
		6A					—					—					
		10A					●					●					
		13A					—					—					
		16A					●					●					
		20A					—					—					
		25A					●					●					
		32A					—					—					
		40A					●					●					
		50A					—					—					
		63A					—					—					
EN 60 898		0.5A					—					—					
Type TDC		—					—					—					
Characteristics: C		—					—					—					
⑤		—					—					—					
		1A					●					●					
		2A					—					—					
		3A					—					—					
		4A					—					—					
		6A					●					●					
		10A					●					●					
		13A					●					●					
		16A					●					●					
		20A					●					●					
		25A					●					●					
		32A					●					●					
		40A					●					● ①					
		50A					●					● ①					
		63A					●					● ①					
EN 60 898		0.5A					—					—					
Type TDD		—					—					—					
Characteristics: D		—					—					—					
⑥		—					—					—					
		1A					●					●					
		2A					—					—					
		3A					—					—					
		4A					—					—					
		6A					●					●					
		10A					●					●					
		13A					●					●					
		16A					●					●					
		20A					●					●					
		25A					●					●					
		32A					●					●					
		40A					●					● ①					
		50A					●					● ①					
		63A					●					● ①					
OUTLINE DIMENSIONS (mm)		—					—					—					
		—					—					—					
a		45					45					45					
b		73					73					73					
c		43					43					43					
d		87					87					87					
e		36					36					36					
f		17.8 35.6 53.4 71.2					17.8 35.6 53.4 71.2					17.8 35.6 53.4 71.2					
STANDARD FEATURES		—					—					—					
Contact position indicator		—					—					●					
Number of units per box		12 6 4 3					12 6 4 3					12 6 4 3					
IP 20 Terminal protection		●					●					●					
ACCESSORIES		—					—					—					
Shunt trip		—					—					●					
Auxiliary contacts		—					—					●					
Terminal covers		●					●					●					
Padlock device		●					●					●					

NOTES: ● : Yes or available.

— : No or not available.

① : AC breaking capacity (kA) @ 415V – 6/6kA, [I_{cu}/I_{cs}]

② : Available on request – ICP–M, U and L characteristics.

③ : 1 pole + neutral and 3 pole + neutral available on request.
(4.5kA and 6kA types only).

④ : Inst is set between 3 I_n to 5 I_n

⑤ : Inst is set between 5 I_n to 10 I_n

⑥ : Inst is set between 10 I_n to 20 I_n



6

Other Electrical Distribution Equipment

Special Circuit Breakers

※ Special Circuit Breakers are available on request.

Circuit Breaker with Magnetic Trip Only

This is a standard breaker excluding thermal overload trip. It has an instantaneous tripping characteristic only. This is used where short-circuit protection is exclusively needed.

Breakers for Coordination

High-INST Trip Breaker

This is a standard molded case circuit breaker (electronic type) with a high instantaneous tripping value, in one-point fixed. This is recommended for zone selective interruption or the primary side of transformer application.

Low-INST Trip Breaker

Low Instantaneous Trip Breakers is also available on request. Ask TERASAKI or its agent for details.

Special Environment Breakers

TERASAKI Standard Breakers are manufactured based on the "standard operating conditions"

If an application in other places than those of "standard operating conditions", specify as "Special Environment Breakers" when ordering your breakers.

Standard Operating Conditions

- Operating ambient temperature: -5°C to 40°C
If used at a higher temperature than 40°C , the operating current has to be reduced;
 50°C : Approx. 90%
 60°C : Approx. 70%
- Relative humidity: Below 85%
- Altitude: Below 2000m
- Atmosphere: Contents of dust, smoke, corrosive gases, flammable gases, moisture and salt should be moderately low.

Low-temperature Circuit Breaker

This is a breaker designed for use in low temperature environment. Storage and operating conditions are -40°C and -20°C respectively. Since the operating characteristics of the low-temperature breaker are adjusted at 40°C (45°C), the characteristics vary at a lower temperature.

Conditions: This type of breaker should not be used where thermal changes are rapid and dew-formation and freezing exist.

Anti-fungus Circuit Breaker (Tropical-proof)

Dielectric strength and other electrical properties may deteriorate under unusual high temperature and high-humidity conditions. This type of breaker is specially prepared with special surface treatment, special materials and tropical-proof processing.

Operating conditions are:

Temperature: Below 60°C
Humidity: Below 95%

Conditions: This type of breaker should be used in a constant humidity environment without rapid thermal changes and dew formation.

Highly Anti corrosive Circuit Breaker

In highly corrosive or saline atmosphere, breakers are used in sealed corrosion-proof boxes or enclosures.

However, in a place where the influence of corrosive gases is relatively low a simpler method is applicable:

This is the Highly Anti-corrosive Breaker with special surface treatment of high corrosion-proofness.

This eliminates needs for such a box or enclosure.

 **CAUTION**

Be sure to read the instruction manual carefully to ensure correct and safe use of the product.

 **TERASAKI OVERSEAS NETWORK**

TERASAKI (EUROPE) LTD.

80 Beardmore Way, Clydebank Industrial Estate, Clydebank, Glasgow, G81 4HT. SCOTLAND (U. K.)

Telephone : 44-141-941-1940 / Fax : 44-141-952-9246

E-mail : marketing@terasaki.co.uk

<http://www.terasaki.com/>

TERASAKI ITALIA s.r.l.

Via Ambrosoli 4a, 20090 Rodano, Milano, ITALY

Telephone : 39-02-92278300 / Fax : 39-02-92278320

E-mail : terasaki@terasaki.it

<http://www.terasaki.it/>

TERASAKI ESPAÑA, S.A.U.

Roma, s/n, 08400 Granollers, Barcelona, SPAIN

Telephone : 34-93-879-60-50 / Fax : 34-93-870-39-05

E-mail : terasaki@terasaki.es

<http://www.terasaki.es/>

TERASAKI SKANDINAVISKA AB

Frasarvagen 32 SE-142 50 SKOGÅS Sweden

Telephone : 46-8-556-282-30 / Fax : 46-8-556-282-39

E-mail : info@terasaki.se

<http://www.terasaki.se/>

TERASAKI CIRCUIT BREAKERS (S) PTE. LTD.

9 Toh Guan Road East 03-01 Alliance Building, Singapore 608604, SINGAPORE

Telephone : 65-6744-9752 / Fax : 65-6748-7592

E-mail : tecs@pacific.net.sg

TERASAKI ELECTRIC (M) SDN. BHD.

Lot 3, Jalan 16/13D, 40000 Shah Alam, Selangor Darul Ehsan, MALAYSIA

Telephone : 60-3-5549-3820 / Fax : 60-3-5549-3960

E-mail : terasaki@terasaki.com.my

TERASAKI DO BRASIL LTDA.

Rua Cordovil, 259-Parada de Lucas, 21250-450 Rio de Janeiro-R. J., BRAZIL

Telephone : 55-21-3301-9898 / Fax : 55-21-3301-9861

E-mail : terasaki@terasaki.com.br

<http://www.terasaki.com.br/>

TERASAKI ELECTRIC (CHINA) LIMITED

72 Pacific Industrial Park, Xingtang Zengcheng, Guangzhou 511340, CHINA

Telephone : 86-20-8270-8556 / Fax : 86-20-8270-8586

E-mail : terasaki@public.guangzhou.gd.cn

 **TERASAKI ELECTRIC CO., LTD.**

Head Office : 7-2-10 Hannancho, Abenoku, Osaka, JAPAN

Circuit Breaker Division : 7-2-10 Kamihigashi, Hiranoku, Osaka, JAPAN

Telephone : 81-6-6791-9323 / Fax : 81-6-6791-9274

E-mail : int-sales@terasaki.co.jp

<http://www.terasaki.co.jp/>